

Article number: 204160M1060D3S

Description: E+G levelling foot

GN 41-60-M10-60-D3-S

Note: S Without nut, External hexagon at the bottom

## Measures

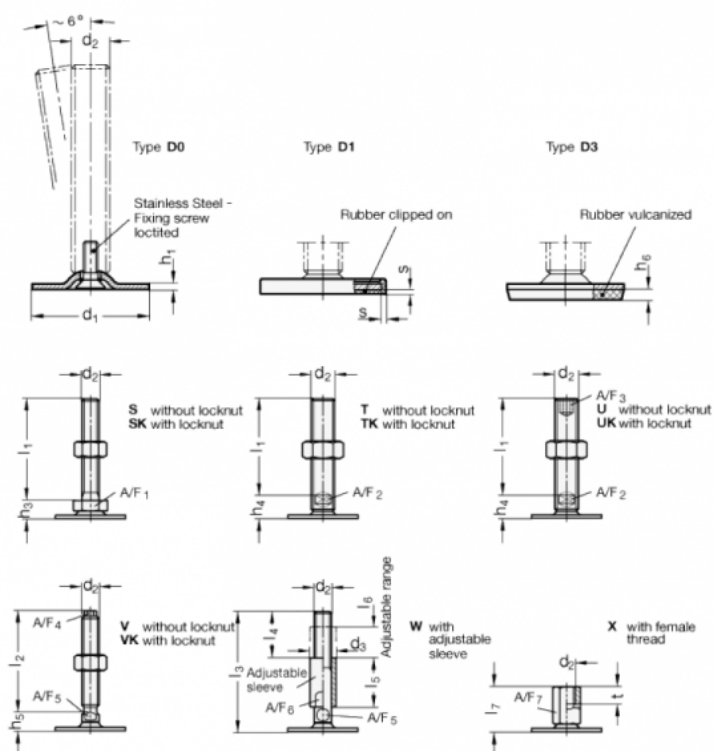

A/F1	= 17
d1	= 60
d2	= M10
h1	= 2.5
h3	= 11
h6	= 4.5
l1	= 60
s	=